

PNEUMATIC LOW HEADROOM

STANDARD FEATURES

- ▷ Toku rotary vane motor
- ▷ Robust epicycle gearbox
- ▷ Failsafe automatic internal disc brake
- ▷ Upper & lower limit switches
- ▷ Cast steel housing
- ▷ Internal silencing down to 80 dB(A)
- ▷ Alloy safety swivel hooks with safety catch
- ▷ Load chain of European manufacture EN818-7
- ▷ Automatic, adjustable load limiter

AVAILABLE OPTIONS

- ▷ Marine specification
- ▷ Collision bumpers
- ▷ ATEX specification ZONE 1 & 2
- ▷ Articulated trolleys
- ▷ Rack & pinion drive
- ▷ Travel limits
- ▷ Air Service units
- ▷ Festoon systems
- ▷ Radio control remote
- ▷ Main air shut off valve
- ▷ Special paint systems
- ▷ Beam brake
- ▷ Other travel speeds

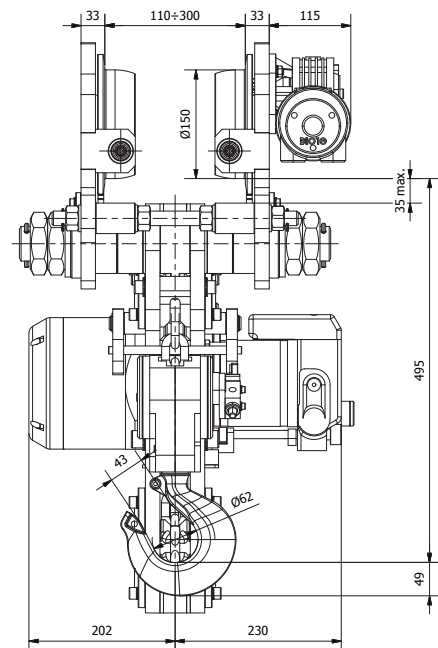
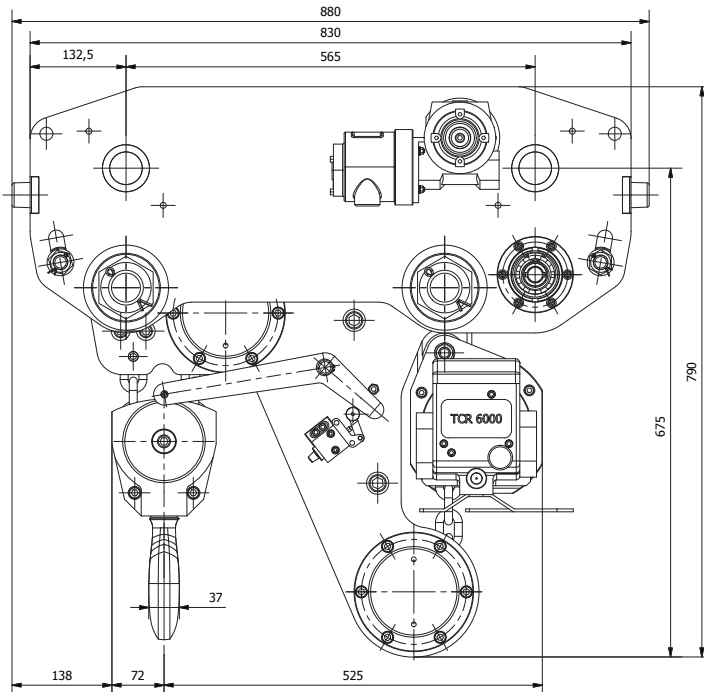

MODEL	TCR-6000-LHR
WLL	6000 kg
CHAIN FALLS	2
LIFTING SPEED FULL LOAD (M/MIN)	1.4
LIFTING SPEED WITHOUT FULL LOAD (M/MIN)	2.9
LOWERING SPEED FULL LOAD (M/MIN)	2.3
TRAVEL SPEED (M/MIN)	6.0
HOIST AIR CONSUMPTION (L/SEC)	33
TROLLEY AIR CONSUMPTION (L/SEC)	25
INLET CONNECTION	0.75"
WEIGHT WITH 3M HOL	310 kg
ADDITIONAL METRE HOL	5.4 kg
FLANGE MINIMUM (MM)	110
FLANGE MAXIMUM (MM)	300
G.A. DRAWING	1551-00



TCR-6000-LHR