

PNEUMATIC CHAIN HOISTS

STANDARD FEATURES

- ▷ High strength cast iron body
- ▷ Toku rotary vane motor
- ▷ Robust epicycle gearbox
- ▷ Failsafe automatic internal disc brake
- ▷ Mechanical upper & lower switches
- ▷ Cast steel housing
- ▷ Internal silencing down to 80 dB(A)
- ▷ Alloy safety swivel hooks with safety catch
- ▷ Load chain 22 x 66mm of European manufacture to EN818-7
- ▷ Automatic, adjustable load limiter

AVAILABLE OPTIONS

- ▷ Marine specification
- ▷ Special paint systems
- ▷ Corrosion protection
- ▷ ATEX specification
- ▷ Chain collectors (galvanised or stainless steel)
- ▷ Air Service units
- ▷ Festoon systems
- ▷ Radio control
- ▷ Main air shut off valve

MODEL	WLL	LIFTING SPEED WITH LOAD	LIFTING SPEED WITHOUT LOAD	LOWERING SPEED WITH LOAD
TNC-25TWLPE	25000 kg	0.6 m/min	1.0 m/min	0.7 m/min
	AIR CONSUMPTION LIFTING	AIR CONSUMPTION LOWERING	AIR CONNECTION	MINIMUM HOSE DIA.
TNC-25TWLPE	90 l/sec	100 l/sec	1" BSP	1" HOSE
	CHAIN FALLS	WORKING PRESSURE	WEIGHT WITH 3M HOL	ADDITIONAL METRE HOL
TNC-25TWLPE	2	6 bar	490 kg	21.8 kg

C = CORD CONTROL PE = PENDANT

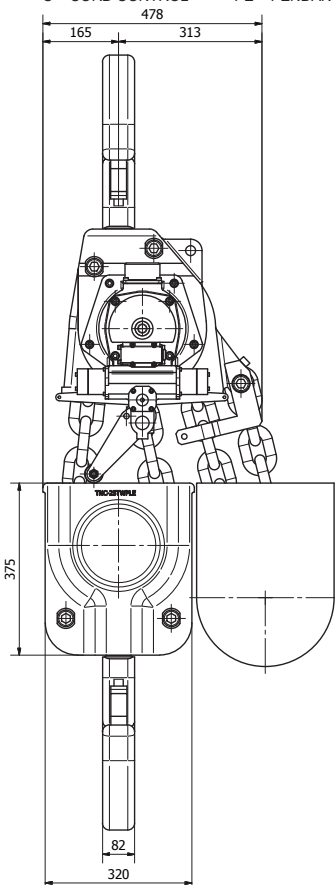

All measurements are in mm
Information subject to change without notice

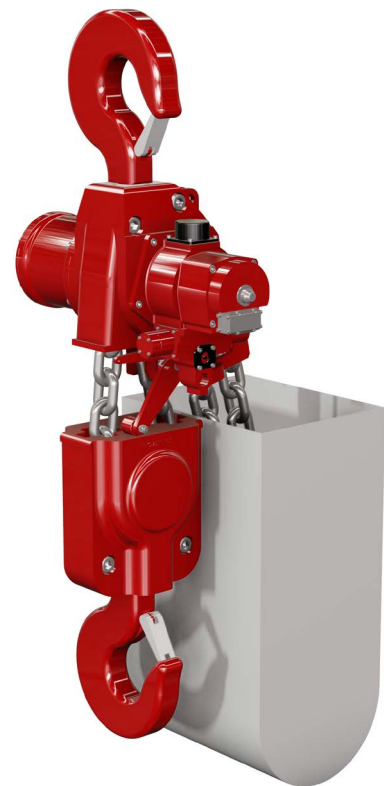
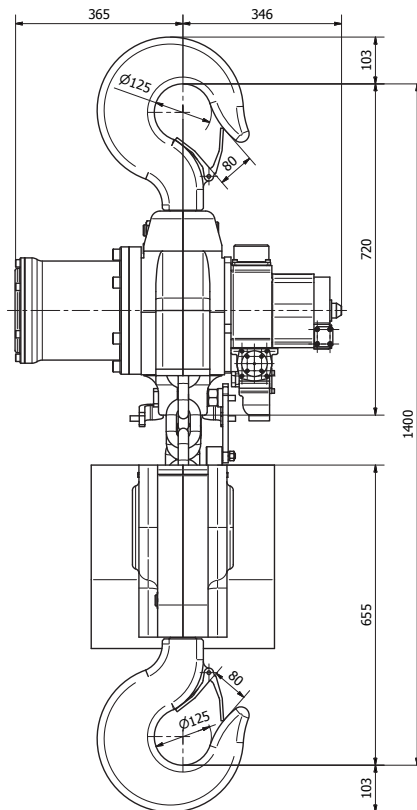

Image for illustration purposes only

TNC-25TWLPE