

PNEUMATIC CHAIN HOISTS

STANDARD FEATURES

- ▷ High strength cast iron body
- ▷ Toku rotary vane motor
- ▷ Robust epicycle gearbox
- ▷ Failsafe automatic internal disc brake
- ▷ Mechanical upper & lower switches
- ▷ Cast steel housing
- ▷ Internal silencing down to 80 dB(A)
- ▷ Alloy safety swivel hooks with safety catch
- ▷ Load chain 11.2 x 34mm of European manufacture to EN818-7
- ▷ Automatic, adjustable load limiter

AVAILABLE OPTIONS

- ▷ Marine specification
- ▷ Special paint systems
- ▷ Corrosion protection
- ▷ ATEX specification
- ▷ Chain collectors (galvanised or stainless steel)
- ▷ Air Service units
- ▷ Festoon systems
- ▷ Radio control
- ▷ Main air shut off valve

MODEL	WLL	LIFTING SPEED WITH LOAD	LIFTING SPEED WITHOUT LOAD	LOWERING SPEED WITH LOAD
TCR-6000/2	6000 kg	1.4 m/min	2.9 m/min	2.3 m/min
	AIR CONSUMPTION LIFTING	AIR CONSUMPTION LOWERING	AIR CONNECTION	MINIMUM HOSE DIA.
TCR-6000/2	33 l/sec	43 l/sec	1/2" BSP	3/4" HOSE
	CHAIN FALLS	WORKING PRESSURE	WEIGHT WITH 3M HOL	ADDITIONAL METRE HOL
TCR-6000/2	2	6 bar	91 kg	5.4 kg

C = CORD CONTROL PE = PENDANT

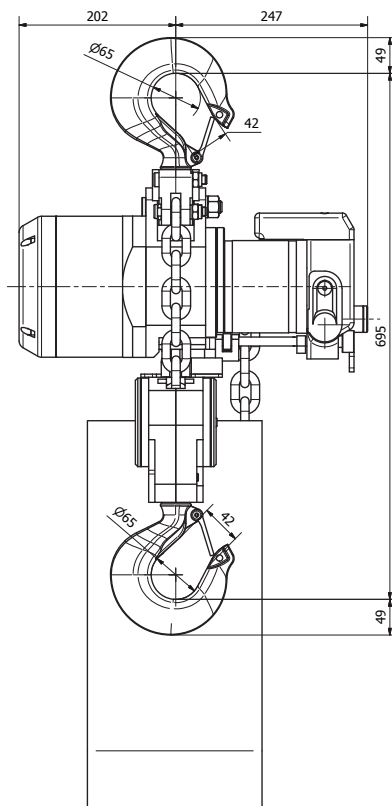
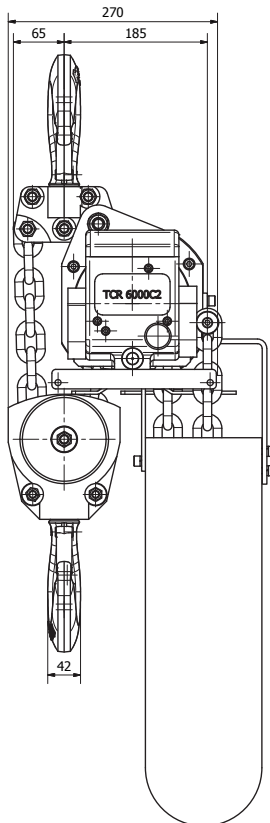

All measurements are in mm
Information subject to change without notice

Image for illustration purposes only

TCR-6000/2