

PNEUMATIC CHAIN HOIST & TROLLEY

STANDARD FEATURES

- ▷ Toku rotary vane motor
- ▷ Robust epicycle gearbox
- ▷ Failsafe automatic internal disc brake
- ▷ Choice of pendant controls or control stations
- ▷ Upper & lower limit switches
- ▷ Cast steel housing
- ▷ Internal silencing down to 80 dB(A)
- ▷ Alloy safety swivel hooks with safety catch
- ▷ Load chain of European manufacture to EN818-7
- ▷ Automatic, adjustable load limiter
- ▷ Trolley to suit various flange profiles
- ▷ Anti-tilt & anti-drop plates
- ▷ High efficiency motor gearbox
- ▷ Heavy duty sealed wheel bearings
- ▷ Wheel profile to suit parallel or tapered flanges

AVAILABLE OPTIONS

- ▷ Marine specification
- ▷ Special paint systems
- ▷ Collision bumpers
- ▷ ATEX specification ZONE 1 & 2
- ▷ Chain collectors (PVC, galvanised or stainless steel)
- ▷ Articulated trolley
- ▷ Low headroom units
- ▷ Rack & pinion drive
- ▷ Travel limits
- ▷ Air service units
- ▷ Festoon systems
- ▷ Radio control remote
- ▷ Optional travel speeds
- ▷ Beam brake



Image for illustration purposes only

HOIST MODEL	TCR-9000/3-AT10S
WLL	9000 kg
CHAIN FALLS	3
LIFTING SPEED FULL LOAD	0.9 m/min
LIFTING SPEED WITHOUT LOAD	1.9 m/min
AIR CONSUMPTION (L/SEC)	33
WORKING PRESSURE	6 bar
AIR CONNECTION	3/4" BSP
MINIMUM HOSE DIA.	3/4"
WEIGHT 3M HOL & TROLLEY	290 kg
ADDITIONAL METRE HOL	8.1 kg
TROLLEY MODEL	
	AT10S
G.A. DRAWING	
	1503-22
FLANGE	
RANGE 1	110-180
RANGE 2	180-240
RANGE 3	240-300
STANDARD TROLLEY TEMP RANGE	-10 to +50°C
OPTIONAL TROLLEY TEMP RANGE	-20 to +70°C
TRAVEL SPEED (M/MIN)	8
WHEEL MATERIAL	Steel
ATEX WHEEL MATERIAL	Bronze
MINIMUM BEND RADIUS (M)	2.5
NUMBER OF WHEELS	4
DRIVEN WHEELS	2
MAX AIR CONSUMPTION	40 l/sec
HOSE ID TROLLEY	3/4"

AT_S = STANDARD AT_ATX = ATEX

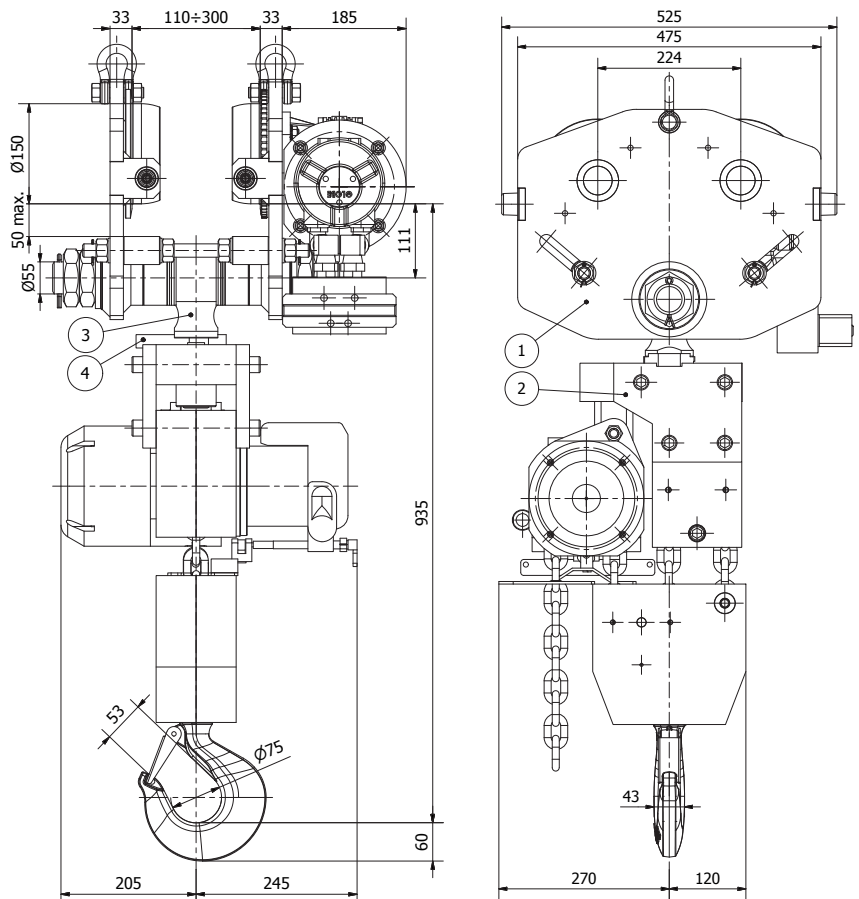

All measurements are in mm
Information subject to change without notice